

Medical Rail System
and
Bed Space Management Accessories



Medical Rail System and Bed Space Management Accessories



Key to accessories, within the catalogue, for use in the following applications:

- Wall rail mounted Can be used with wall rail from Ohmeda, Therapy Equipment, East, Modura (S&W or MIE) and all 25 - 30mm high x 10mm deep profiles to BS EN12218:1999
- MEDÆS medical trunking fitted with integral rail
- MEDÆS ceiling mounted pendant systems
- MEDÆS Trolley
- MEDÆS Genesis beam system

Contents:

Medical Rail & Accessories

Page 1	Medical Rail System
Page 2	Adjustable arm, infusion support and chart holder
Page 3	Shelves, baskets and storage unit
Page 4	Sphygmomanometers, catheter holders, glove box holders, sharps bin holder etc.
Page 5	Miscellaneous
Page 6	Patient lighting
Page 7	Medical examination lighting

Medical Trunking fitted with Rail

Page 8	Accessories for MEDÆS trunking
Page 9	Trunking mounted shelves, drawer and wall protector

Ceiling Mounted Pendant Systems & Ventilator Trolley

Page 10	Ventilator trolley, shelf and drawer Docking claw
Page 11	Ventilator trolley

Genesis Overhead Beam & Shelving System

Page 11	Rail spans, bars etc. and infusion poles
Page 12	Shelves and drawers

AGS Receiver

Page 19	Anaesthetic gas scavenging receiver
---------	-------------------------------------



Medical Rail System

Universal Medical Rail System

Based on a 30mm x 10mm profile, which is the mid-point of the 25-35mm high x 10mm deep envelope specified in BS EN12218:1999. It comprises a single extruded aluminium section which can be fitted directly to the wall.

- Suitable for both general and heavy duty purposes
- No additional brackets or fixing kits needed
- Feather-edge rail trim caters for variation in walls and prevents a build-up of dirt behind rail
- Cream trim blends with MEDÆS trunking system and accessories
- Easy to install
- 250kgs maximum load per metre run, providing sufficient wall fixings are correctly installed
- Will accept other types of Rail Clamp, including those used by Medirail, Modura (S&W or MIE), East, Draeger and any clamp complying to the new European standard; between 25-35mm high x 10mm deep

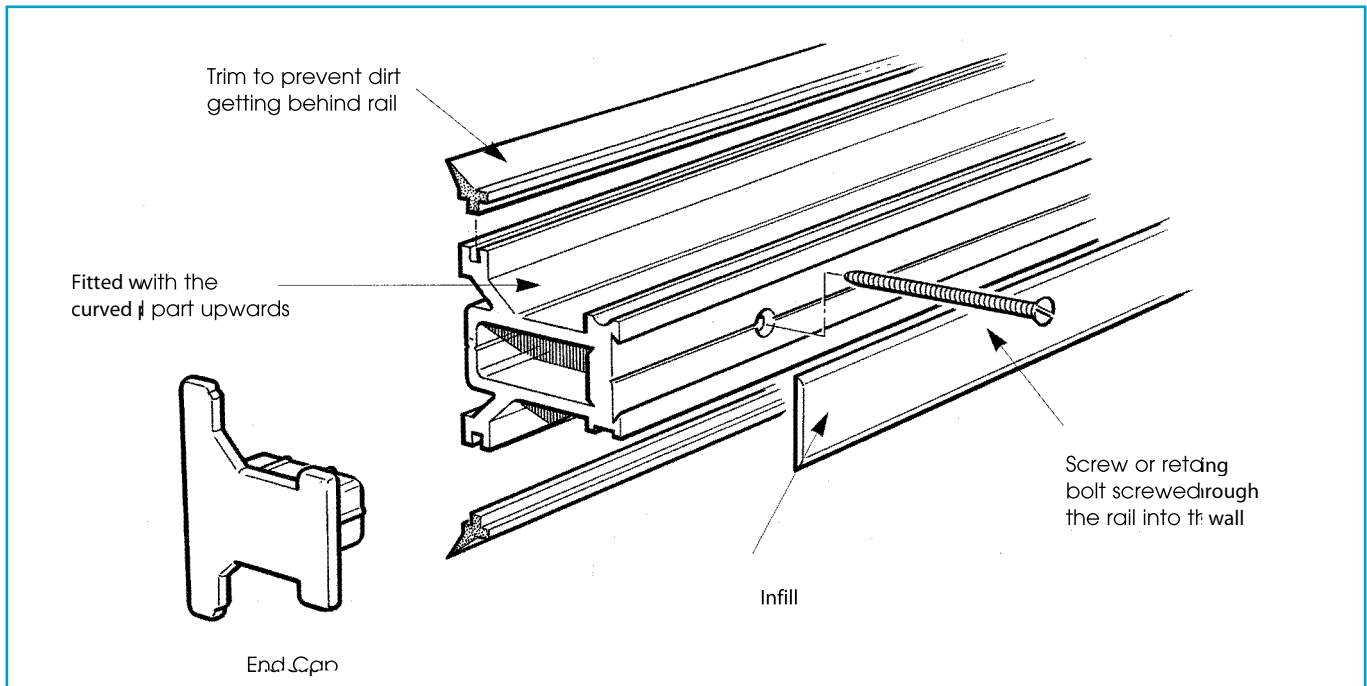
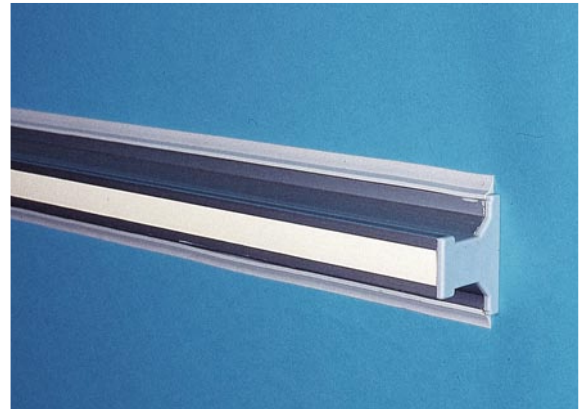

Universal Rail

Inclusive of trim, infill, end caps and wall fixings (standard screw and plug for fixing to brick or to wooden noggins)

- 2001185 1 metre long
- 2001186 1.5 metres long
- 2001187 2 metres long
- 2001188 3 metres long

Other lengths up to 3 metres can be provided for an additional charge.

- 2001165 End Cap, pair
Only required if the rail is cut on-site
- 2001168 Joining kit
To join lengths together

Accessories for mounting on Medical Rail

Adjustable Articulated Arm W T P Tr G

A new concept in adjustable arms for ventilator hoses and also for running IV lines to the patient.

Just press the **green** button • adjust arm • release **green** button.

- No screwed joints to wear out
- Flexible end shaft to ease final positioning
- Each joint has the possibility of 63 positions
- Lightweight, easy to position

2001129 Triple articulated arm with a total reach of 1325mm
 2001128 Double articulated arm with a total reach of 875mm

Infusion Support

The adjustable height IV poles have:

- Patented, thumb operated, rapid height adjustment of bags or bottles of fluids using just one hand
- Capacity to mount volumetric and syringe pumps

W T P Tr G

2001161 3-hook adjustable IV pole (not shown)
 25mm Ø, height variation from 1060mm up to 1680mm
 2001162 4-hook adjustable IV pole (A)
 25mm Ø, height variation from 1060mm up to 1680mm

If its is intended that these infusion poles are to hold more than one or two infusion devices it is advisable to support them from two parallel rails in which case an additional rail clamp is necessary.

2001184 Additional Clamp with 25mm Ø hole (F)

W T P Tr G

2001177 3-hook rigid IV pole (B)
 length = 1200mm x 18mm Ø
 2001178 4-hook rigid IV pole (not shown)
 length = 1200mm x 18mm Ø

If its is intended that these infusion poles are to hold more than one or two infusion devices it is advisable to support them from two parallel rails in which case an additional rail clamp is necessary.

2001183 Additional Clamp with 18mm Ø hole (G)

W T P Tr G

1828396 Utility Post, short (C)
 length = 300mm x 19mm Ø
 Rail mounting for single infusion or syringe pump.

1828398 Utility Post, long (D)
 length = 1000mm x 19mm Ø
 Requires support from two rails and has capacity to mount

several infusion and/or syringe pumps.

2001086 4-hook, rail mounted boom (E)
 1200mm high x 830mm reach, it is supplied with two clamps and requires two rails to support it.

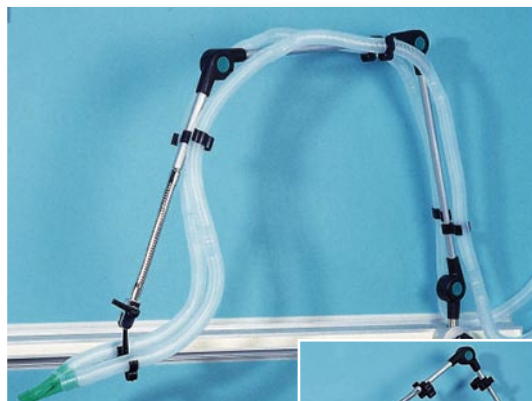

Note: Hose is not included

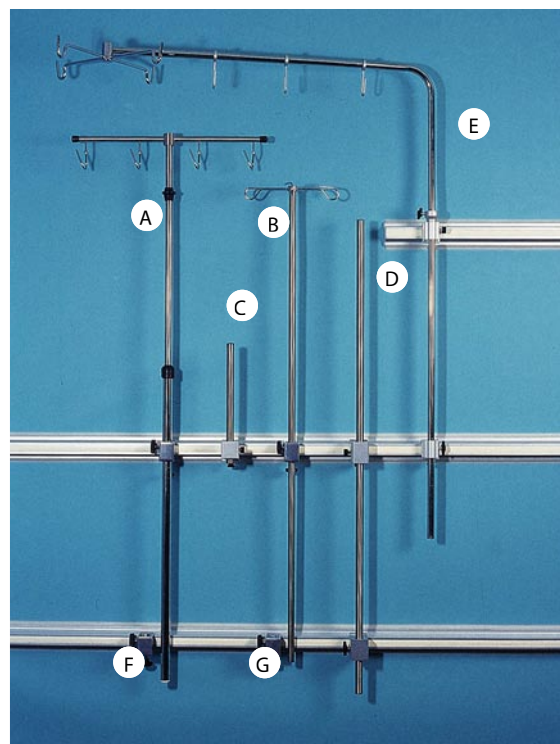

Accessories for mounting on Medical Rail

Shelves and Baskets W T P Tr G

Storage Baskets **!Temporarily Unavailable!**

- | | | |
|---------|--|-----|
| 2001149 | Sphygmomanometer cuff storage basket | (A) |
| 2001150 | 170mm wide x 140mm deep x 130mm high | (B) |
| 2001151 | 580mm wide x 120mm deep x 100mm high | (C) |
| 2001152 | 300mm wide x 120mm deep x 100mm high | (D) |
| 2001153 | 460mm wide x 240mm deep x 100mm high with three dividers | (E) |

The baskets are vinyl coated for ease of cleaning and longer life.

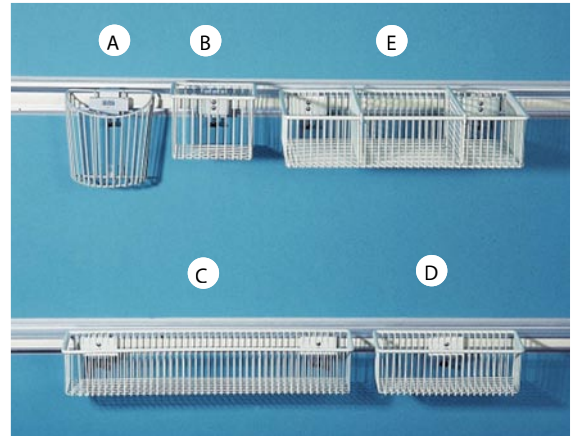

Shelves W T

- | | |
|---------|--|
| 2001111 | Shelf, 540mm wide x 400mm deep |
| 2001112 | Shelf, 740mm wide x 400mm deep (not shown) |
- Adjustable support legs ensure versatility to suit any rail system
 - Can be used with the integral rail on MEDÆS trunking
 - Constructed with cream laminate face for ease of cleaning
 - Edged with hardwood
 - Metal lip inset into shelf to prevent equipment slipping off
 - Maximum load 50kgs
- | | |
|---------|------------------------|
| 2001114 | Drawer unit 120mm deep |
|---------|------------------------|
- Sliding runners on ball bearings for smooth action
 - 120mm deep
 - Finished in RAL 9001 cream to match the shelf



W T P Tr G

- | | | |
|--------------------|--|-----|
| 2001090 | Mayo tray, hinged Discontinued | |
| | 435mm wide x 295mm deep. The stainless steel tray is removable for cleaning/autoclaving. The tray is mounted in a robust cream painted frame | |
| 2001147 | Stainless steel instrument tray and holder | (B) |
| | 320mm wide x 275mm deep | |
| 2001146 | Stainless steel basin and holder | (C) |
| | 195mm Ø x 120mm deep | |

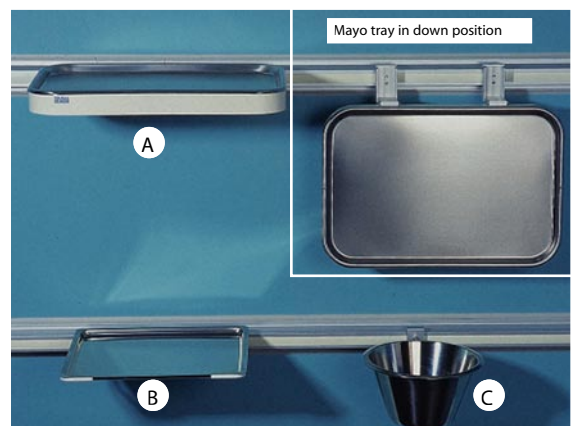

Accessories for mounting on Medical Rail

Sphygmomanometers W T P Tr G

- 2001133 Sphygmomanometer, Aneroid with standard adult cuff
- 2001134 Sphygmomanometer, Mecurial with standard adult cuff
- 2001149 Sphygmomanometer cuff basket Temporarily Unavailable

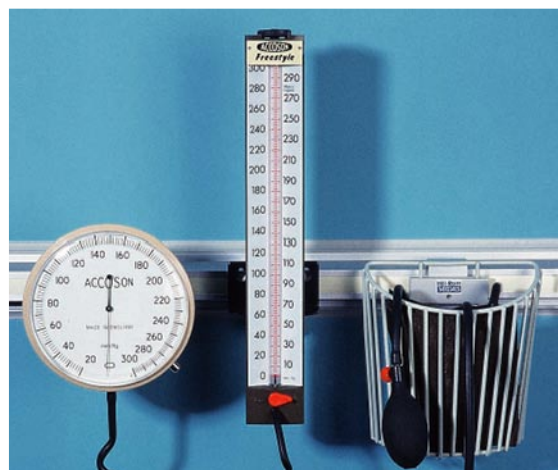

Storage, general W T P Tr G

- 2001139 Catheter holder, 2 bays wide
410mm high x 90mm deep x 133mm wide. With a clear perspex front which can also be slid out to clean the inside of the holder.
- 2001140 Catheter holder, 5 bays wide
410mm high x 90mm deep x 325mm wide. With a clear perspex front which can also be slid out to clean the inside of the holder.
- 2001141 Adjustable glove box holder
caters for any glove box up to 165mm wide and 95mm deep
- 2001142 Glove holder
for loose gloves for general, non-sterile use
- 2001145 Notes holder
Internal size 270mm wide x 60mm deep to accept A4 folders.



Gloves
not included



- 2001091 Sharps bin holder, adjustable
Caters for circular bins up to approx 270mm Ø or square bins up to approx 220mm wide. Depth of bin approx 400mm high. Equates to approx a 20 litre capacity container.
- 2001947 Replacement velcro straps for Sharps Bin Holder.



Note:
Sharps bin
not included

Accessories for mounting on Medical Rail

Miscellaneous W T P Tr G

2001085 Cord Wrap (A)
To keep cables tidy
Note: excludes cable

2001109 Resuscitator holder (B)
With 30mm clip

1828395 Cable and tube clip (C)
To keep cables tidy, it simply clips onto medical rail.
Note: Will not fit 25 x 10 rail profile

2001103 Rail clamp with hook (D)

2001104 Rail clamp with V-slide (E)

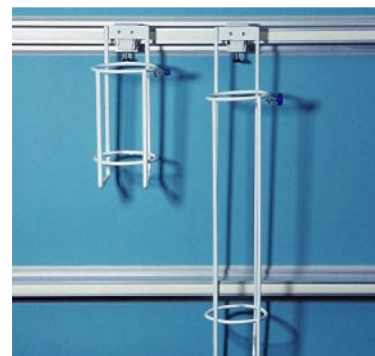
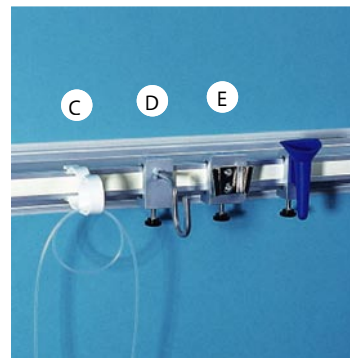
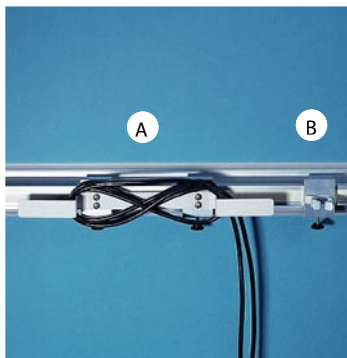

W T P Tr G

2001949 Cylinder Holder, "E" size with Male V-plate
Requires V-clamp 2001104

2001948 Cylinder Holder, "D" size with Male V-plate
Requires V-clamp 2001104

W T P Tr G

2001138 Rubbish bag holder
Overall size 245mm wide x 150mm deep

Bags not included

Accessories for mounting on Medical Rail

Patient Lighting

The advanced design of the Medicoool electronic bed-head lamps ensures optimum light comfort for patients and medical staff. The latest compact fluorescent lamps are used in conjunction with anti-glare dispersing lenses to provide soft, cool, uniform lighting.

This dispersing lens also protects the patient from any danger of shattered glass as required under Department of Health guidelines. Electronic ballasts are built into each lamp to provide flicker free light as well as to reduce energy consumption and extend lamp life. A 40w incandescent version is also available.

2001993 Medicoool reading lamp, model M13G1(M)PL fitted and supplied with 13 watt compact fluorescent lamp, electronic ballast, 3m cable and 13amp plug.

- Stylish and attractive
- Illuminated handle incorporating ergonomically positioned switch
- Soft, cool light from anti-glare diffuser
- Electronic ballast -
 - Energy saving (17% over wound ballast, 80% over incandescent lamps)
 - Longer lamp life (50% longer life than wound ballasts)
 - Flicker free (wound ballasts flicker at 50Hz mains frequency)
 - Soft start (silent start-up and extends lamp life)
- CE marked, IEC 598, EMC, SAB 69
- Max reach 1060mm



2001994 Rail clamp for Medicoool lamp
2001952 Pole mounting bracket for Medicoool lamp (not shown)

2001156 Medicoool reading lamp, model M60G1(M)PL fitted and supplied with 40 watt incandescent lamp, 3m cable and 13amp plug.

- Stylish and attractive
- Illuminated handle incorporating ergonomically positioned switch
- Low running temperature
- Soft, cool light from anti-glare diffuser
- CE marked, IEC 598, EMC, SAB 69
- Max reach 1060mm



2001944 Rail clamp for Medicoool lamp
2001952 Pole mounting bracket for Medicoool lamp (not shown)

The ergonomic shaped head can be rotated through 270° whilst the discreet luminous stripes guide the patient's hand to the lamp handle and switch

Accessories for mounting on Medical Rail

Medical Examination Lighting W T P Tr G

Intense Cool Light



All Coolview lamps use the latest tungsten halogen dichronic lamps to produce intense, cool, filtered light ideal for medical examination applications. C50 models achieve illumination levels of 52,000 lux at 0.5 metres.

Spot & Flood Light



Coolview C35 is the first product of its type to offer both concentrated spot lighting and diffused flood lighting in the same lamp. This versatile lamp is ideal for a wide variety of examinations over both large and small wound sites.

Dimming Function



Coolview C50 and C35 ranges include the facility to dim the light to 66% of its full intensity for delicate examinations and to reduce eye strain during prolonged treatment.

Daylight Filter



Coolview lamps produce cool filtered light. The addition of the filter option corrects the essentially artificial light to that of natural "cool daylight" as used in major operating lamps. This filter technology is unique to Coolview and provides un-surpassed quality of light.

2001939 Coolview examination light, model C50GX(M)PL fitted and supplied with 50 watt dichronic reflector lamp, electronic transformer, 3m cable and 13amp plug.

- Provides a high intensity light 52,000 lux @ 0.5m.
- Dimming function provides 100% or 66% intensity
- Daylight filter option for 4300 Kelvin
- Double-wall lamp head for cool running
- Electronic transformer - high efficiency, reversible overload, short circuit and over temperature protection
- Max reach 1060mm
- CE marked, IEC 598, EMC, SAB 69

2001945 Rail clamp for Coolview examination light

2001946 Pole mounting bracket for Coolview light (not shown)



Coolview examination light

2001155 Coolview examination light, model C35GX(M)PL fitted and supplied with 35 watt dichronic reflector lamp, electronic transformer, 3m cable and 13amp plug.

- Provides a high intensity light 20,000 lux @ 0.5m.
- Provides 5,000 lux medium intensity flood light suitable for reading
- Dimming function provides 100% or 66% intensity
- Daylight filter option for 4300 Kelvin
- Double-wall lamp head for cool running
- Electronic transformer - high efficiency, reversible overload, short circuit and over temperature protection
- Max reach 1060mm
- CE marked, IEC 598, EMC, SAB 69

2001945 Rail clamp for Coolview examination light

2001946 Pole mounting bracket for Coolview light (not shown)



Coolview head



C35GX(M)PL
Dual bulb head



Daylight filter

Medical Trunking fitted with rail

MEDÆS Medical Trunking can be supplied with an integral 30 x 10 medical rail which satisfies a new European Standard. The rail now allows you to organise, control and locate life support equipment and medical accessories exactly where needed - and change them as the patient's condition changes. Medical equipment just where you want it.



In addition to all the accessories shown the usability of the trunking can be further enhanced by adding a semi-movable trolley fitted with a shelf edged with medical rail.

Medical Trunking fitted with rail

2001111 Shelf, 540mm wide x 400mm deep **W T**

2001112 Shelf, 740mm wide x 400mm deep (not shown)
When hung from the top rail the adjustable stops require to be located in the top set of holes.

- Adjustable support legs ensure versatility to suit any rail system
- Can be used with the MEDÆS trunking system rail
- Constructed with cream laminate face for ease of cleaning
- Edged with hardwood
- Metal lip inset into shelf to prevent equipment slipping off
- Maximum load 50kgs



Shelf mounted on lower integral rail. Supports in lower set of holes and adjusted to a longer length.

Shelf mounted on upper integral rail. Supports in top set of holes and adjusted to a shorter length.

2001114 Drawer **W T P Tr G**

- Sliding runners on ball bearings for smooth action
- 120mm deep
- Colour RAL 9001 cream to match the shelf and trunking



Wall and Trunking Protection

It is a familiar situation when a bed is accidentally rammed against a wall or even worse into the trunking or medical gas outlets, flowmeters and suction controllers. Protect this important equipment by fitting a wall protector.

2001073 Wall Protector



Ceiling Mounted Pendant Systems



Pendant head configured with examples from the range of accessories. Pole mounted examination light, sharps bin holder, short utility post, cord wrap and coiled lead set (on IV pump)



Pendant head configured with independent monitor arm, 4-hook drip boom, triple articulated arm, stop clock, large basket with dividers and a small basket. The pendant shelves are edged with 30 x 10 stainless steel rail.

Ventilator Trolley, for use with Pendant

In addition to the rail mounted accessories a ventilator trolley is available for use either with a pendant or separately on its own. The shelf is based on the Genesis shelf so, in addition to supporting a ventilator, it can accept most of the extensive range of rail or pole mounted accessories.

2001060 Ventilator trolley

- Two 900mm long poles, 38mm Ø
- Heavy duty castor base with 125mm Ø castors
- Two braked castors at the front
- Colour RAL 9002 light grey to match pendants

2001126 Ventilator shelf

- Edged with over 2m of 30 x 10 medical rail as standard
- Rail acts as a lip to prevent medical equipment being accidentally pushed off
- Shelf adjustment is simple and requires no tools
- Capable of carrying up to 65kgs of equipment
- Size 780mm wide x 470mm deep overall (useful with 610mm)
- Colour RAL 9002, light grey

2001113 Drawer

- Sliding runners on ball bearings for smooth action
- 120mm deep
- Finished in RAL 9002, light grey

2001176 Docking claw (A)

For use with Hill-Rom MED/ES ceiling pendants, a mating bracket must be supplied as part of the pendant. Length specific to Ventilator Trolley 2001060. The Docking Claw can be engaged and disengaged very simply and quickly to the docking bracket without the need for any tools. Once engaged the trolley is effectively locked within the footprint of the pendant service console.

2001061 Claw Support Assembly (B)

Necessary to locate the Docking Claw to the Ventilator trolley.

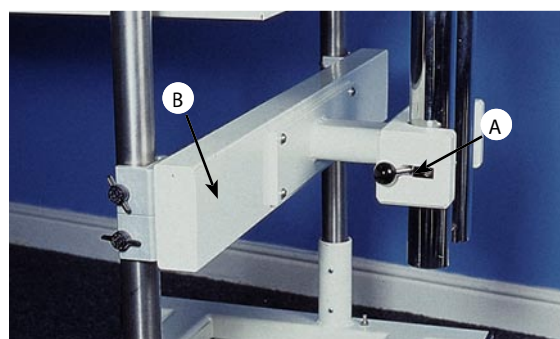

Ventilator Trolley

In addition to being used with a ceiling pendant the trolley can be used as a useful platform for both ventilator and also other medical equipment.

A few examples of accessories which can be chosen to be supported from the trolley.

























2001126	Ventilator shelf
2001113	Drawer
2001128	Double articulated arm
1828396	Utility post, short (rail mounted)
2001090	Hinged Mayo tray
1828393	Medical rail bar
2001091	Sharps bin holder
2001949	Cylinder holder, "E" size with male V-plate
2001104	Rail clamp with V-slide
2001106	Stop clock
1828399	Utility post, long (pole mounted)
2001278	Extension socket, 4 way x 13amp, unswitched (pole mounted)

Other accessories suitable for rail or pole mount indicated with the  icon can be selected.



Genesis Overhead Beam and Shelving System Accessories

In intensive and neonatal care and other special care areas more and more medical equipment is needed to provide treatment. Flexibility, configurability and adaptability is important so that no constraints are placed upon medical staff using equipment for differing patient needs and changing medical requirements over the life of the capital equipment. The MEDÆS range of medical accessories offer this flexibility, configurability and adaptability.

1828391	Twin medical rail bar (C)  	38mm Ø pole mount. The 30 x 10 stainless steel rails are each 400mm long. Height adjustment is easily achieved by the use of a thumb screw.
1828392	Medical rail span (B)  	Provides two 770mm 30 x 10 stainless steel rails spanning the 38mm Ø carrier poles on the MEDÆS Genesis system and ventilator trolley. Height adjustment is easily achieved by the use of two thumb screws.
1828393	Medical rail bar (A)  	Single 30 x 10 stainless steel rail 400mm long on a pole clamp. To suit up to a maximum of 38mm Ø
1828395	Cable and tube clip (E)     	To keep cables tidy, it simply clips around the 38mm Ø carrier pole.
1828397	Utility Post, short (Pole mounted) (D)  	Length = 300mm x 19mm Ø. Pole mounted for single infusion or syringe pump.
1828396	Utility Post, short (Rail mounted)     	Length = 300mm x 19mm Ø. Rail mounted for single infusion or syringe pump. (not shown)
1828399	Utility Post, long (Pole mounted) (F)  	Length = 1000mm x 19mm Ø. Pole mounted to support infusion and/or syringe pumps.
1828398	Utility Post, long (Rail mounted)     	Length = 1000mm x 19mm Ø. Requires support from two rails and will support infusion and/or syringe pumps. (not shown)



Genesis Overhead Beam and Shelving System Accessories

2000629 Genesis shelf

- Edged with over 2m of 30 x 10 medical rail as standard
- Rail acts as a lip to prevent medical equipment being accidentally pushed off
- Shelf adjustment is simple and requires no tools
- Capable of carrying up to 65kgs of equipment
- Size 780mm wide x 470mm deep overall (useful width 610mm)
- Colour RAL 9010, white



2001113 Drawer

- Sliding runners on ball bearings for smooth action
- 120mm deep
- Finished in RAL 9002, light grey

1828381 6-hook adjustable IV pole, rail mounted

The adjustable height IV pole has:

- Patented, thumb operated, rapid height adjustment of bags or bottles of fluids using just one hand
- Capacity to support up to six bottles or bags of fluid
- Height adjustment from 700mm up to 1050mm



Lighting

2001939 Coolview examination light, model C50GX(M)PL

2001155 Coolview examination light, model C35GX(M)PL

2001946 Pole mounting bracket for Coolview light

2001993 Medicool reading lamp, model M13G1(M)PL (not shown)

2001156 Medicool reading lamp, model M60G1(M)PL (not shown)

2001952 Pole mounting bracket for Medicool lamp (not shown)



Anaesthetic Gas Scavenging Receiver

2001001 Anaesthetic Gas Scavenging Receiver

- Meets BS EN 740:1999 and BS 6834:1987 (1992)
- MRI compatible
- Suitable for paediatric appliances
- 'A' weighted sound pressure level at 130 l/min - 38dbA
- Robust white acetal construction
- Supplied with 3m disposal hose
- Supplied with white transfer hose (disposable) and pressure relief valve
- Size 500mm x 80mm Ø
- Weight 1kg
- Supplied with male 'V' plate. Requires female 'V' rail clamp or wall plate

2001104 Rail clamp with V-slide

2002396 Wall mounted V-slide





MEDÆS Ltd., Telford Crescent, Staveley, Derbyshire S43 3PF, England
Tel: +44 (0) 1246 474 242 - Fax: +44 (0) 1246 472 982 - info@medaes.com - www.medaes.com